

75BS.L500.100W

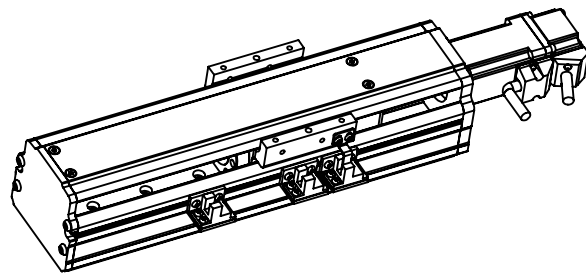
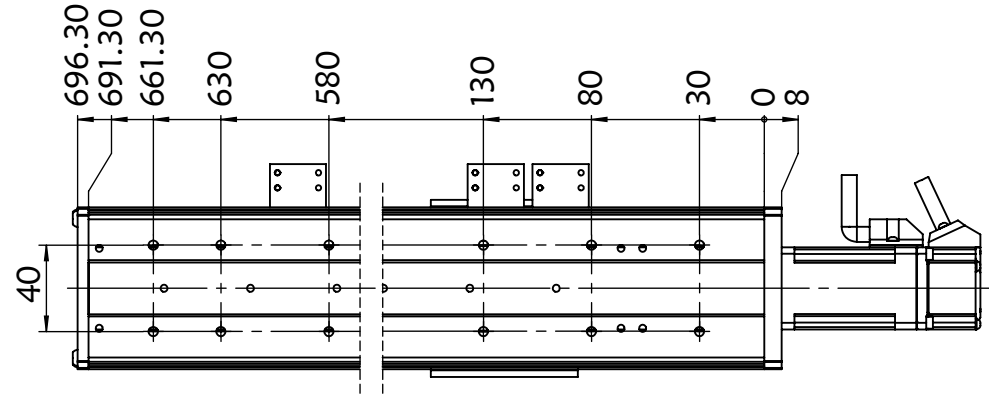
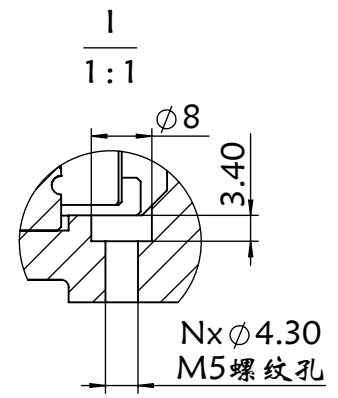
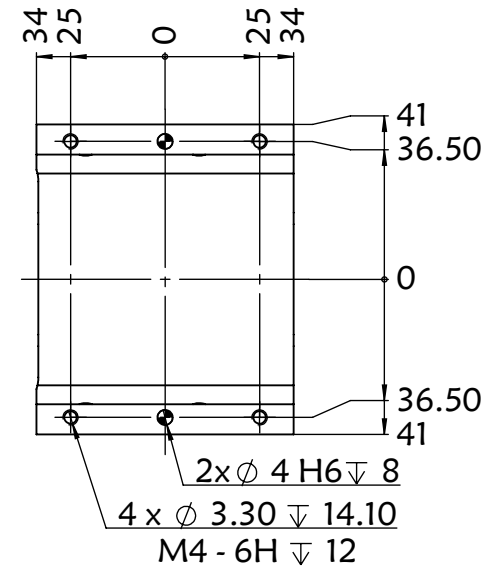
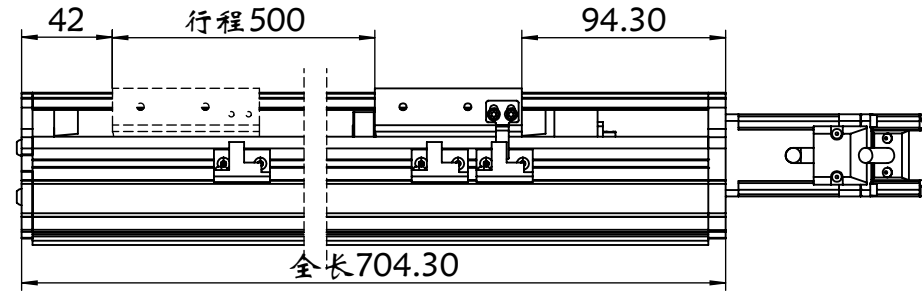
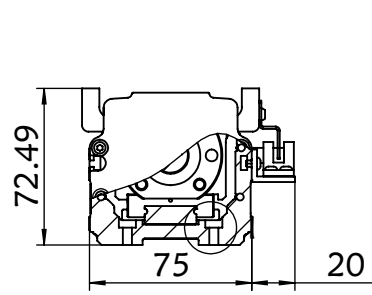

审核		单位	mm	 上海信进
重量	6.001	比例	1:5	
数量	1	材质		
第三视角	设计	MT	产品名称	75BS.直连外置
	日期	2019/6/29	工程图号	75BS.L500.100W
	纸页	1-1	替代	

TEL:18321692610
QQ:71080628